

Features

- Low Cost
- Small Size and Low Profile
- Superior Repeatability (Lot-to-Lot Variation)
- Typical Insertion Loss: 0.8 dB
- Typical Isolation: 24 dB
- Typical Amplitude Balance: 0.3 dB
- Lead-Free SOIC-8 Package
- 100% Matte Tin Plating over Copper
- Halogen-Free “Green” Mold Compound
- 260°C Reflow Compatible
- RoHS* Compliant Version of DS54-0005

Description

M/A-COM’s MAPDCC0009 is an IC-based monolithic power divider using M/A-COM’s GMIC technology in a low cost SOIC-8 plastic package. This 4-way power divider is ideally suited for applications where PCB real estate is at a premium and standard packaging for automated assembly and low cost are critical. Typical applications include infrastructure, portables, and peripheral devices (PCMCIA cards) for wireless standards such as GSM, AMPS, CDPD, RAM, and ARDIS. Available in tape and reel.

The MAPDCC0009 is fabricated using a passive-integrated circuit process. The process features full-chip passivation for increased performance and reliability.

Functional Diagram

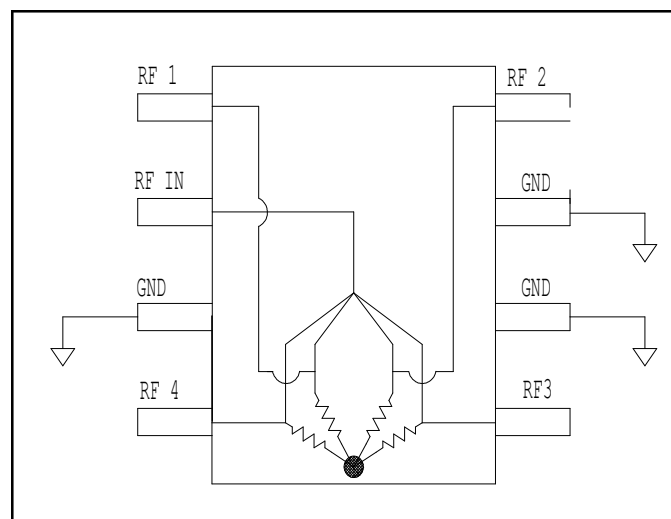

1. Pins 2, 6, and 7 must be DC and RF grounded.

Ordering Information

Part Number	Package
MAPDCC0009	Bulk Packaging
MAPDCC0009-TR	2000 piece reel
MAPDCC0009-TB	Sample Test Board

Note: Reference Application Note M513 for reel size information.

Pin Configuration

Pin No.	Function	Pin No.	Function
1	RF 1	5	RF 3
2	RF IN	6	GND
3	GND	7	GND
4	RF 4	8	RF 2

* Restrictions on Hazardous Substances, European Union Directive 2002/95/EC.

Electrical Specifications: $T_A = +25^\circ\text{C}$, $Z_0 = 50\Omega$

Parameter	Units	Min	Typ	Max
Insertion Loss Above 6.0 dB	dB	—	0.8	1.1
Isolation	dB	20	24	—
VSWR Input	—	—	1.4:1	1.7:1
Output	—	—	1.25:1	1.5:1
Amplitude Balance	dB	—	0.3	0.6
Phase Balance	°	—	3	6

Absolute Maximum Ratings ^{2,3}

Parameter	Absolute Maximum
Input Power ⁴	1W CW
Operating Temperature	-40°C to +85°C
Storage Temperature	-65°C to +150°C

- Exceeding any one or combination of these limits may cause permanent damage to this device.
- M/A-COM does not recommend sustained operation near these survivability limits.
- With internal load dissipation of 0.125 W maximum.

Handling Procedures

Please observe the following precautions to avoid damage:

Static Sensitivity

GMIC Circuits are sensitive to electrostatic discharge (ESD) and can be damaged by static electricity. Proper ESD control techniques should be used when handling these devices.

Recommended PCB Configuration

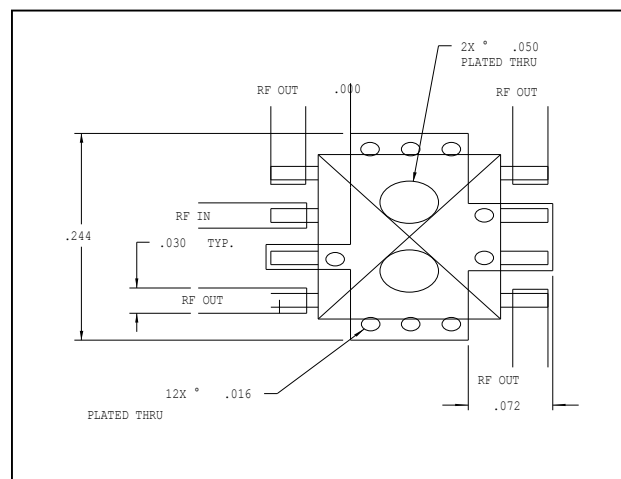

Typical Performance Curves

Insertion Loss vs. Frequency
(Dashed lines show amplitude balance window)

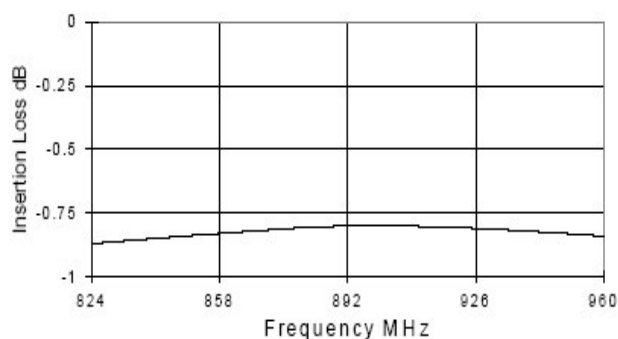

VSWR vs. Frequency

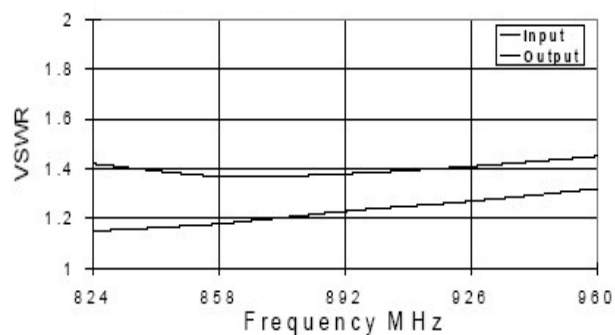

Isolation vs. Frequency

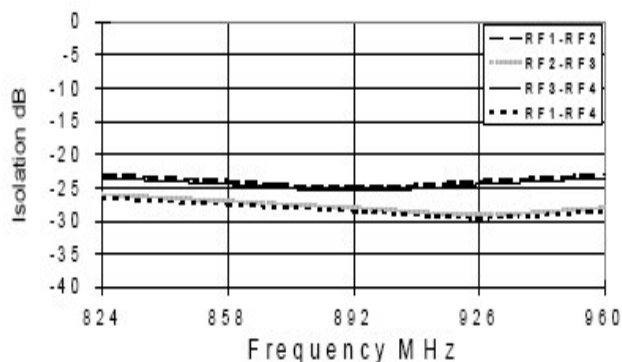

Phase Balance vs. Frequency
(Relative to RF1)

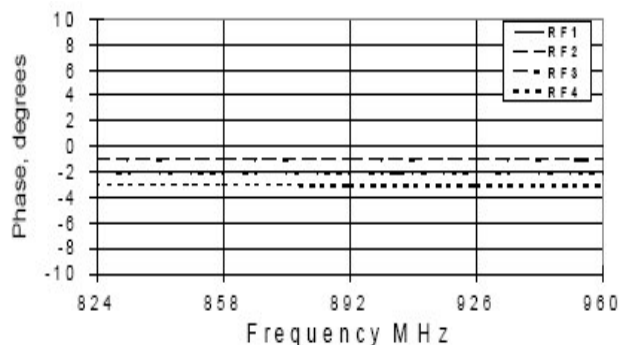

Lead-Free, SOIC-8[†]

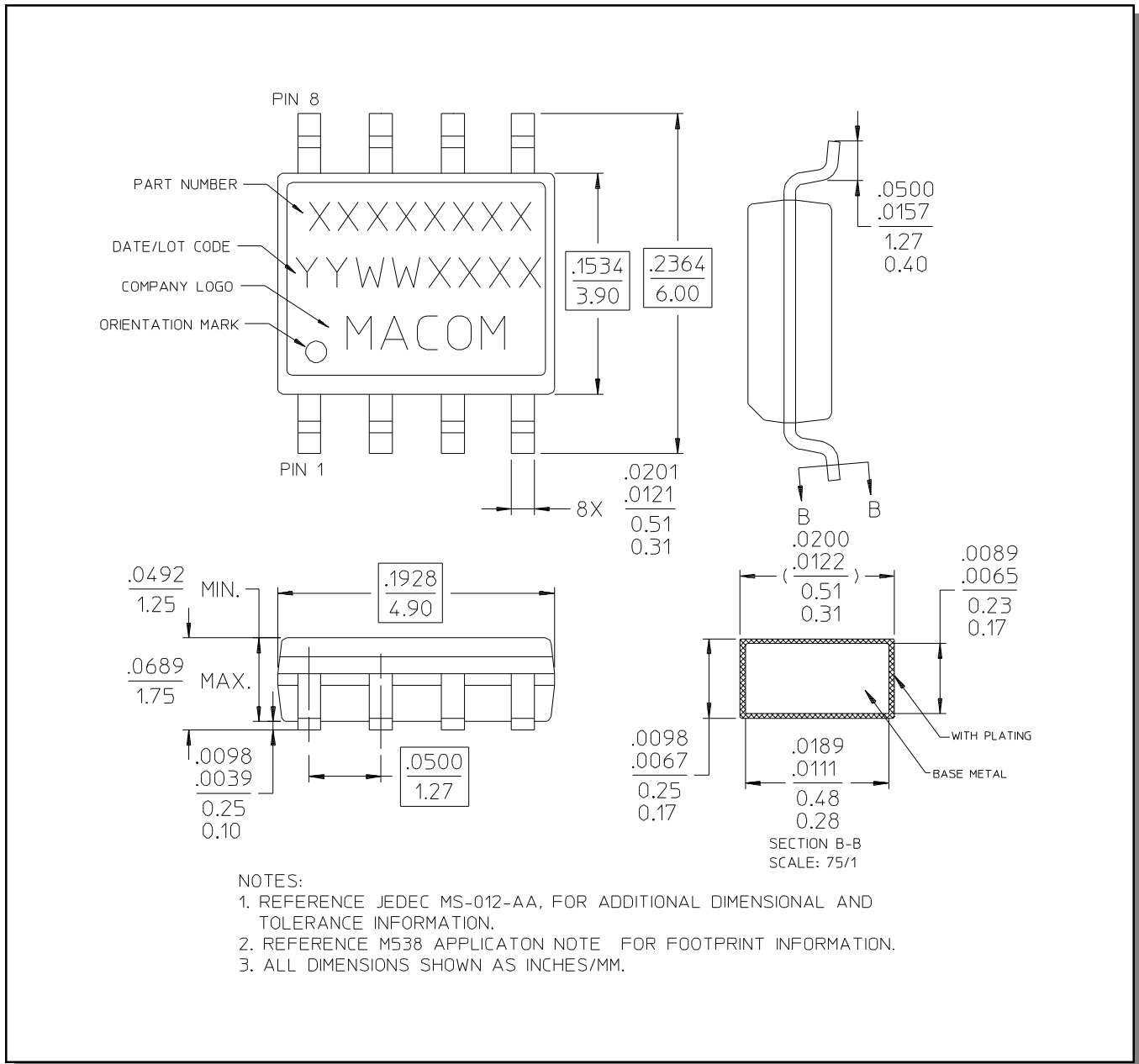

[†] Reference Application Note M538 for lead-free solder reflow recommendations.